



Predictive direct power control of a grid connected photovoltaic system, associated with an active power filter

Lakhdar Belhadji^{a,*}, Mohmaed Nader Amrani^a

^a *Department of Material and Equipment, Research and development center, Algeria*

ARTICLE INFO

Article history:

Received July 17, 2024

Accepted September 12, 2024

Keywords:

Photovoltaic System,
Shunt Active Power Filter,
Maximum Power Point
Tracking (MPPT),
Fuzzy Logic Control,
Predictive Direct Power
Control (P-DPC).

ABSTRACT

This paper deals with power quality improvement using a three-phase active power filter (APF) connected to a PV power system. This paper deals with power quality improvement using a three-phase active power filter (APF) connected to a PV power system. The DC-DC boost converter acting as an interface within the PV system and the three-phase voltage source inverter. A fuzzy logic maximum power point tracking (MPPT) controller is used to obtain the maximum power from the PV system. Furthermore, the optimal selection of the inverter switching states is realized by combination of direct power control (DPC) and a predictive method. Modelling and simulation of the system were performed by using Matlab/Simulink software.

1. INTRODUCTION

Photovoltaic (PV) generation systems are very promising renewable energies sources to substitute fossil energy, due to several advantages (Bengourina *et al.*, 2017), such as cost effective, low maintenance efforts, speed of installation, and support of energy independence.

The power electronics conversion chain for a grid connected PV system; associated to an active power filter (APF) has widely investigated in literature (Ouchen *et al.* 2016). Generally, this power electronics chain consists of PV generator, active power filter, electrical grid and polluting electrical load.

An important characteristic of PV system is the nonlinear current voltage curve; it depends on the load variation and the climatic conditions such as the solar radiance. A maximum power point tracking algorithm (MPPT) is used to maximize the output power by tracking of the MPP called maximum power point (Amrani & Dib, 2013). A several MPPT techniques has been proposed for PV generator, such as Hill Climbing (HC), perturbation and observation (Rekioua & Serir, 2013), incremental conductance

* Corresponding author, E-mail address: Lakhdar.belhadji@gmail.com



(Chung-Yuen *et al.* 1994), open-circuit voltage methods, short-circuit current algorithm (Barra & Rahem, 2014), the MPPT methods based artificial intelligence (Amrani & Dib, 2013). In this paper we will give method of intelligent pursuit of maximum power point, is fuzzy logic controller.

On the other hand, different topologies of shunt active power filters have proven their effectiveness in various applications where a variety of control strategies were implemented such as instantaneous active and reactive power control (Merabet *et al.* 2013) and direct power control (Boukezata & al. 2016). The internal current control loops and PWM modulator block are not mandatory in this method. The instantaneous errors between estimated values and the controlled values of both active and reactive powers and the instantaneous position of the grid voltage space-vector are used to select the optimal switching state of the VSI (Bouafia *et al.* 2009), This control strategy suffer from main drawbacks, which are the variable and high switching frequency, produced mainly by the switching table and hysteresis controllers which induce undesired harmonic components.

In this study, a predictive DPC (P-DPC) is achieved using a predictive controller to replace the switching table and the hysteresis controllers in the classical DPC. The regulation of DC capacitor voltage is done by an integrator proportional (IP) regulator. The P-DPC control principal is based on the selection of the optimum control vector to be applied during the sampling time. The selection is carried out by optimizing an appropriate cost function in order to get a sinusoidal current with low value of THD (5%). The paper is organized as follows: In the second section, we present the description of the studied system and the predictive DPC. The third section is devoted to the presentation of the control strategy based on a fuzzy logic approach. The simulation results and discussions are presented in the fourth section. Finally, in the fifth section, some conclusions are drawn.

2. SYSTEM DESCRIPTION AND PREDICTIVE DIRECT POWER CONTROL

The system considered in this study is depicted in Fig. 1.

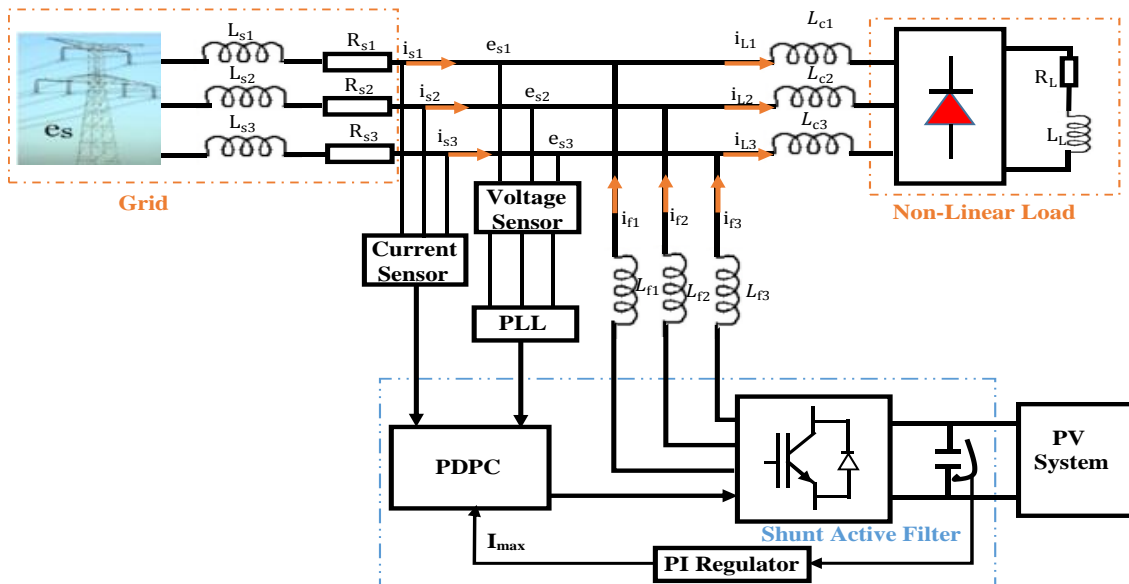

Fig. 1. Schematic of the Grid-connected PV system with APF.

It consists of a PV source connected to a DC-DC boost converter performing a fuzzy logic maximum power point tracking (MPPT). The three phases, two level inverter, connected to the grid, via an inductive filter. This converter acts as a shunt active filter to both compensate harmonics, caused by the

nonlinear load at the AC main, and the reactive power also. In this paper, a predictive direct power control (P-DPC) will be used.

3. PREDICTIVE DIRECT POWER CONTROL STRATEGY (P-DPC)

Fig. 2 shows the block diagram of the used predictive DPC. As can be seen, at each sampling time, for all possible voltage vectors, over a finite prediction horizon, to select the optimal control vector that results in the lowest cost function value (Ouchen et al. 2016; Amrani & Dib, 2016).

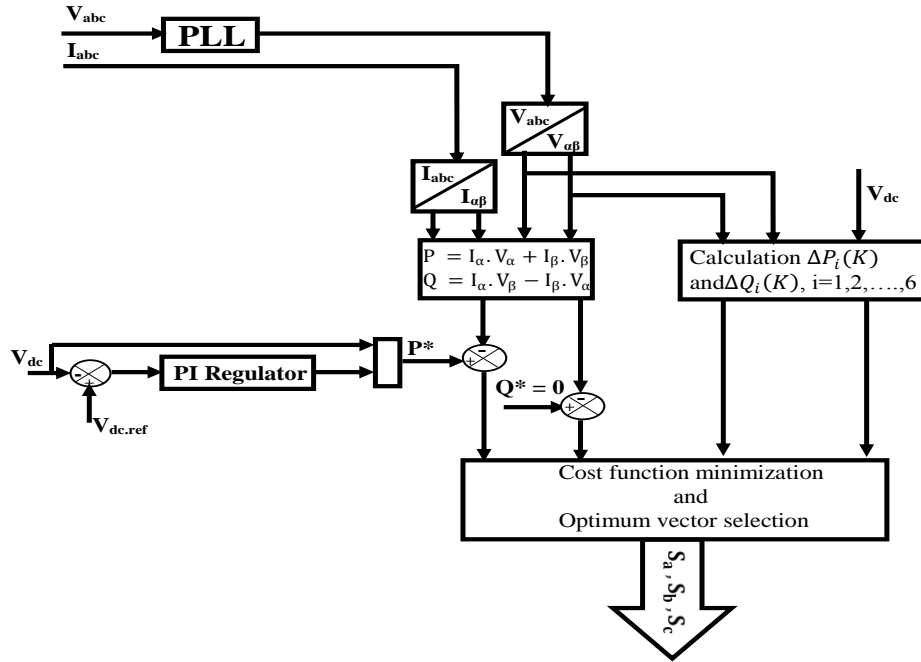

Fig. 2. Synoptic of the P-DPC strategy.

In the stationary reference frame α - β and for a balanced three-phase system, instantaneous active and reactive powers are defined as follows (Amrani & Dib, 2016):

$$\begin{aligned} p &= i_{\alpha}e_{\alpha} + i_{\beta}e_{\beta} \\ q &= i_{\alpha}e_{\beta} - i_{\beta}e_{\alpha} \end{aligned} \tag{1}$$

The voltages e_{β} , e_{α} and the currents i_{β} , i_{α} in the $(\alpha\beta)$ frame are given by the following equations according to Concordia transformation:

$$e_{\alpha\beta} = \begin{bmatrix} e_{\alpha} \\ e_{\beta} \end{bmatrix} = C_0 \begin{bmatrix} e_a \\ e_b \\ e_c \end{bmatrix}, i_{\alpha\beta} = \begin{bmatrix} i_{\alpha} \\ i_{\beta} \end{bmatrix} = C_0 \begin{bmatrix} i_a \\ i_b \\ i_c \end{bmatrix} \tag{2}$$

C_0 indicates Concordia transformation, given by:

$$C_0 = \sqrt{\frac{2}{3}} \begin{bmatrix} 1 & 1/2 & 1/2 \\ 0 & \sqrt{3}/2 & -\sqrt{3}/2 \end{bmatrix} \tag{3}$$

If the sampling period T_s is assumed to be small in comparison with the period of the power-source voltage. As a result, the active and reactive power at the next sampling time is synthesized by the following expression:

$$\begin{bmatrix} P(k+1) \\ q(k+1) \end{bmatrix} = \begin{bmatrix} e_\alpha(k) & e_\beta(k) \\ e_\beta(k) & -e_\alpha(k) \end{bmatrix} \begin{bmatrix} i_\alpha(k+1) \\ i_\beta(k+1) \end{bmatrix} \quad (4)$$

The differential equations of the two-level inverter can be expressed as:

$$L \frac{d}{dt} \begin{bmatrix} i_\alpha(t) \\ i_\beta(t) \end{bmatrix} = \begin{bmatrix} e_\alpha(t) \\ e_\beta(t) \end{bmatrix} - \begin{bmatrix} v_\alpha(t) \\ v_\beta(t) \end{bmatrix} - R \begin{bmatrix} i_\alpha(t) \\ i_\beta(t) \end{bmatrix} \quad (5)$$

By neglecting the influence of the resistance of reactors R and using a discrete first order approximation of (3), the variation of input current vector is obtained as follows:

$$\begin{bmatrix} i_\alpha(k+1) - i_\alpha(k) \\ i_\beta(k+1) - i_\beta(k) \end{bmatrix} = \frac{T_s}{L} \left(\begin{bmatrix} e_\alpha(k) \\ e_\beta(k) \end{bmatrix} - \begin{bmatrix} v_\alpha(k) \\ v_\beta(k) \end{bmatrix} \right) \quad (6)$$

Substituting (6) in (4), one obtains the predictive model at the inverter output, based on variation of active and reactive power during one switching period T_s is given as follows:

$$\begin{bmatrix} P(k+1) - P(k) \\ q(k+1) - q(k) \end{bmatrix} = \frac{T_s}{L} \begin{bmatrix} e_\alpha(k) & e_\beta(k) \\ e_\beta(k) & -e_\alpha(k) \end{bmatrix} \times \left(\begin{bmatrix} e_\alpha(k) \\ e_\beta(k) \end{bmatrix} - \begin{bmatrix} v_\alpha(k) \\ v_\beta(k) \end{bmatrix} \right) \quad (7)$$

The differential equations of the two consecutive sampling instants are given as:

$$\begin{bmatrix} P(k+1) - P(k) \\ q(k+1) - q(k) \end{bmatrix} = \begin{bmatrix} e_\alpha(k) & e_\beta(k) \\ e_\beta(k) & -e_\alpha(k) \end{bmatrix} \times \begin{bmatrix} i_\alpha(k+1) - i_\alpha(k) \\ i_\beta(k+1) - i_\beta(k) \end{bmatrix} \quad (8)$$

One can notice that, only the coupling inductance L_f and the sampling time T_s are the concerned parameters in this predictive model system.

Ideally, the convergence of the controlled quantities to their set values is reached (*Ouchen et al. 2016*) if the following condition is fulfilled:

$$\begin{cases} P^*(K+1) - P(k+1) = 0 \\ q^*(K+1) - q(k+1) = 0 \end{cases} \quad (9)$$

In Eq. (9), the condition can be fulfilled when changes in active and reactive power during the switching time, yield the following values:

$$\begin{cases} \Delta P^*(K) = P^*(K+1) - P(k) \\ \Delta q^*(K) = q^*(K+1) - q(k) \end{cases} \quad (10)$$

The predicted reference values $P^*(k+1)$ and $q^*(k+1)$, is determined according to the method developed for a three-phase PWM rectifier by (*Bouafia et al. 2010*):

$$\begin{cases} P^*(K+1) = 2 \cdot P^*(K) - P(k-1) \\ q^*(K+1) = q^*(K+1) \end{cases} \quad (11)$$

Thus, the optimum switching vector (S_a, S_b, S_c) is selected after minimization of a quadratic cost function correlated to active and reactive power errors:

$$F = \varepsilon_p(k)^2 + \varepsilon_q(k)^2 \tag{12}$$

where:

$$\begin{cases} \varepsilon_p(k) = \Delta P^*(k) - \Delta P_i \\ \varepsilon_q(k) = \Delta q^*(k) - \Delta q_i \end{cases} \quad i = 0,1, \dots \dots 6 \tag{13}$$

4. FUZZY LOGIC MPPT CONTROLLER

Professor Lotfi Zadeh of the University of California at Berkeley proposed the concept of Fuzzy Logic Controller (FLC) in 1965. Ease of use of fuzzy logic on any application, allowed to adapt to solar energy in research the power point maximum. Several researchers have studied this type of algorithm, especially the pursuit of maximum power point tracking (MPPT). In this paper a controller based on fuzzy logic applied to a DC-DC converter (*Amrani & Dib, 2013*) is used due to its robustness and relatively simple design and do not require knowledge of the exact model.

Generally, a basic fuzzy controller structure includes three phases: Fuzzification, inference and eventually block the defuzzification, is shown in Fig. 4.

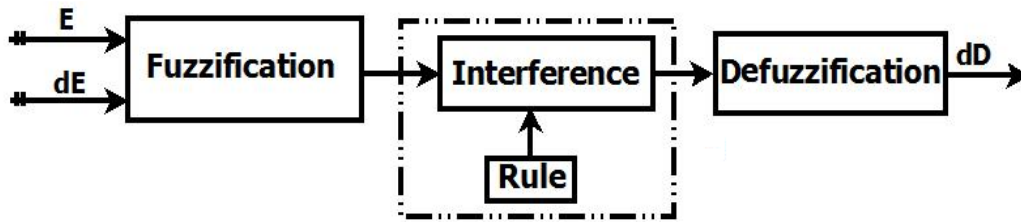

Fig.4. Basic structure of a fuzzy logic controller.

The two inputs of the fuzzy controller are the error (E) and change in error (dE), are calculated as follows:

$$E(k) = \frac{P_{PV}(k) - P_{PV}(k-1)}{V_{PV}(k) - V_{PV}(k-1)} \tag{14}$$

$$dE(k) = E(k) - E(k - 1) \tag{15}$$

where $P_{pv}(k)$ and $V_{pv}(k)$ are, respectively the power and the voltage of PV panel at sampling instants (kT_s).

The error ($E(k)$) is first input variable, which is used for detect the position of power in the PV characteristic (*Amrani & Dib, 2013*), at the instant k , for example the input variable $E(k) > 0$, the MPP is located on the left of the PV characteristic. The variation of the error $dE(k)$ is the second input variable. The sign of the fuzzy logic perturbation (*Guenounou & al. 2014*) is result the second input variable $dE(k)$. Seven linguistic variables are adopted for each of the input/output variables. These are NB (Negative Big), NM (Negative Medium), NS (Negative Small), Z (Zero), PS (Positive Small), PM (Positive Medium), and PB (Positive Big). The seven basic fuzzy divisions for the input and the output variables are presented in Fig. 5. Table. 1 presents the rule table of the fuzzy logic controller. In this

study, for calculating a fuzzy output value, we use Mamdani fuzzy inference method. Using a Centre of gravity method (Bendib et al. 2014), the defuzzification converts this fuzzy output into a numeric value.

Table 1. Table of fuzzy rules.

$e \backslash \Delta e$	NB	NM	NS	Z	PS	PM	PB
NB	NB	NB	NB	NB	NM	NS	Z
NM	NB	NB	NB	NM	NS	Z	PS
NS	NB	NB	NM	NS	Z	PS	PM
Z	NB	NM	NS	Z	PS	PM	PB
PS	NM	NS	Z	PS	PM	PB	PB
PM	NS	Z	PS	PM	PB	PB	PB
PB	Z	PS	PM	PB	PB	PB	PB

Accordingly, the change of the duty cycle is determined by following equation:

$$dD = \frac{\sum_{j=1}^n \mu(D_j) \cdot D_j - D_j}{\sum_{j=1}^n \mu(D_j)} \tag{16}$$

Finally, the duty cycle is determined by:

$$D(k) = D(k - 1) + dD(k) \tag{17}$$

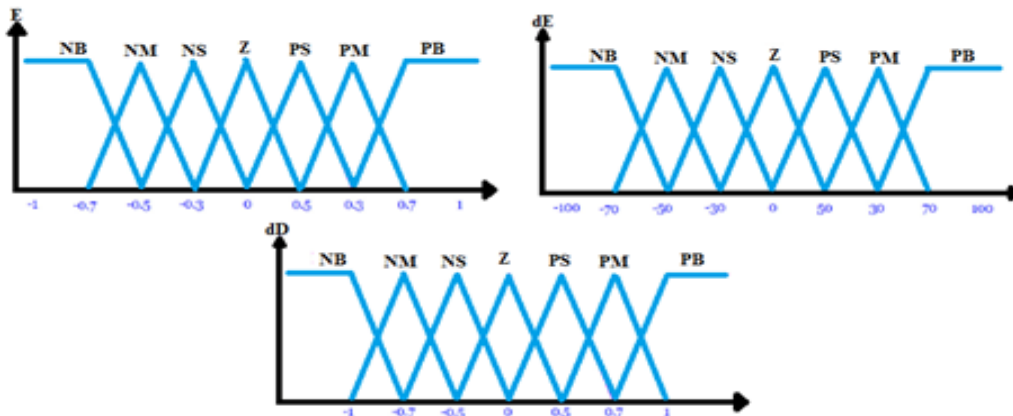

Fig .5. Definition and membership function of (a) the first input variable (E), (b) the first second variable (dE) and (c) the output variable (dD).

5. SIMULATION RESULTS

Simulink with Simpower toolbox has been used for simulating the proposed system.

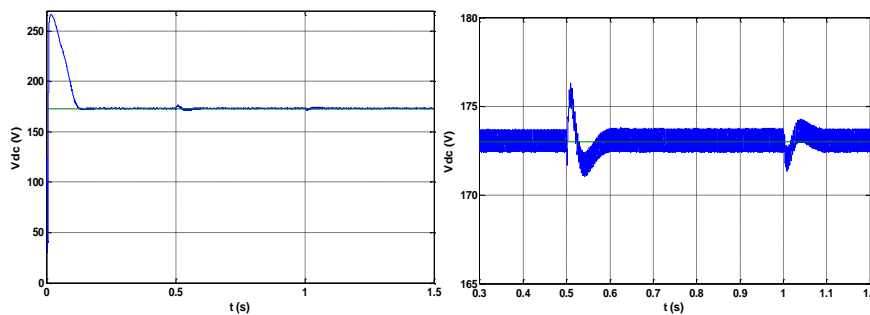

Fig.6. DC bus voltage and its reference.

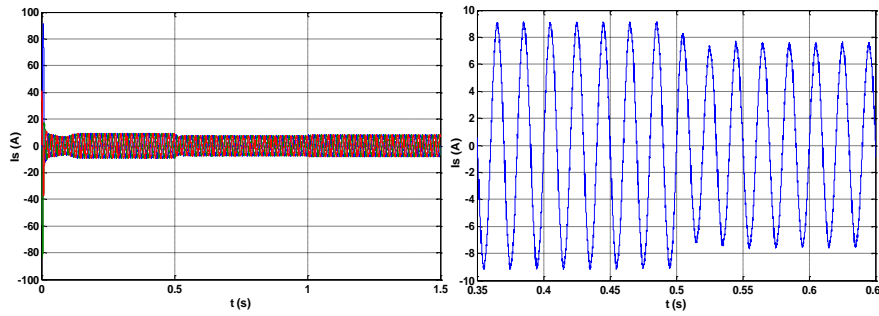

Fig.7. Source current.

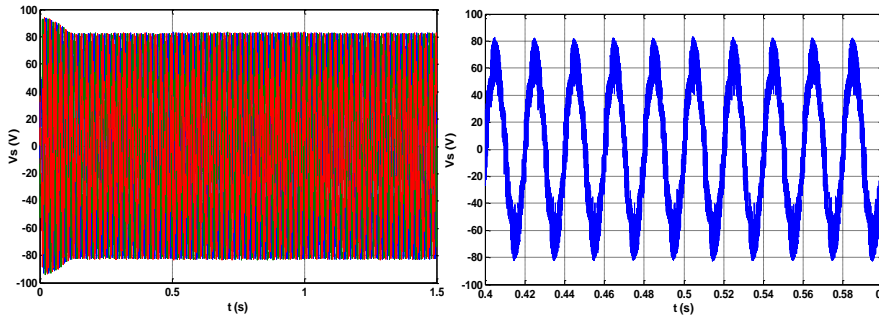

Fig.8. Source voltage.

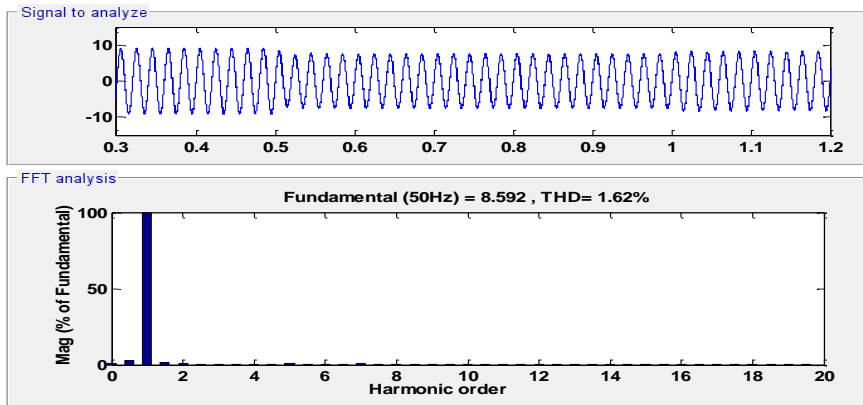

Fig.9. Spectral analysis of the current source.

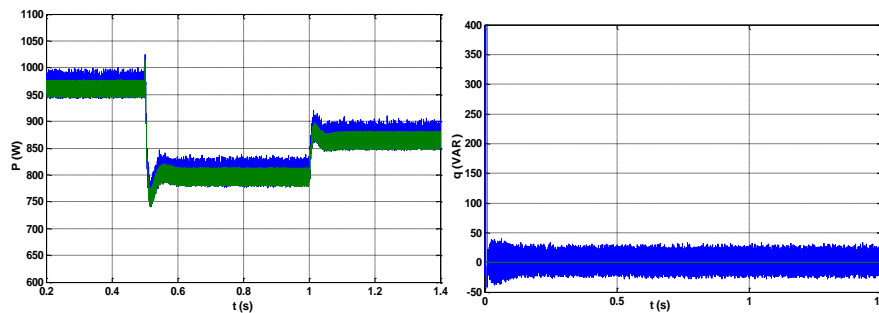

Fig.10. Active and reactive power and its reference.

In Fig. 6, Fig. 7, and Fig.8 shows the DC side capacitor voltage $V_{dc}(V)$, source current $i_s(A)$ and the source voltage $V_s(V)$. It can be observed that the DC bus voltage tracks its reference with good accuracy as depicted. The grid currents present very good tracking performances with a short transient time small harmonic distortion and that are in phase with the grid voltages

Fig.9 shows the source current spectrum analysis. The value of THD is 1.62%, which proves that the proposed SAPF control strategy has the capability of compensating for current harmonics successfully. In Fig.10 one can see that the active power joined its nominal value and that reactive energy becomes null.

6. CONCLUSION

A three-phase active power filter (APF) connected to a PV power system based on a P-DPC and fuzzy logic controller algorithm has been studied in this paper, in order to improve the power quality and compensate reactive power required by nonlinear load. The simulation is performed under MATLAB-Simulink. The results show the efficiency of the proposed shunt APF in all source voltage cases. The source current is sinusoidal and in phase with line voltage source. The THD of the supply current after compensation is 1.62% which is less than 5%; the harmonic limit.

NOMENCLATURE

p	Active power[w]	q	Reactive power [VAR]
i_{α}, i_{β}	Current [A]	e_{α}, e_{β}	Voltage [V]
v_{α}, v_{β}	Voltage vector	V_{dc}	DC bus voltage [V]
P_{PV}	Power of Panel [w]	V_{PV}	Voltage Panel [V]
E	Error	dE	Change in error
D	Duty cycle	dD	Change in duty cycle
S_a, S_b, S_c	Switching vector	C_0	Matrix Concordia transformation
T_s	Sampling period	L_f	Coupling inductance

REFERENCES

- Amrani, M.N., Dib A. (2016). Predictive Direct Power Control of a Grid Connected Three-Phase Voltage Source Inverter for Photovoltaic Systems. International journal of renewable energy research, 6(1).
- Amrani, M.N., Dib, A. (2013). Study of Maximum Power Point Tracking (MPPT) Method Based on Fuzzy Controller, International Conference on Electrical Engineering and Automatic Control.
- Barra, K., Rahem, D. (2014). Predictive direct power control for photovoltaic grid connected system: An approach based on multilevel converters, Energy Conversion and Management, 78, 825-834.
- Bendib, B., F. Krim, H. Belmili, M. Almi, and S. Boulouma, (2014). Advanced fuzzy MPPT controller for a stand-alone pv system, Energy Procedia, 50, 383–392.
- Bengourina, M.R., Rahli, M. and Hassaine, L. (2017). Direct power control of a grid connected photovoltaic system, associated with an active power filter. Revue des Energies Renouvelables 20 (1), 99 – 109.
- Bouafia, A., Gaubert, J.-P. and Krim F. (2010). Predictive direct power control of three-phase pulse width modulation (PWM) rectifier using space-vector modulation (SVM), Power Electronics, IEEE Transactions on, 25(1), 228–236.

- Bouafia, A., Krim, F. and Gaubert, J.-P. (2009). Design and implementation of high-performance direct power control of three-phase PWM rectifier, via fuzzy and PI controller for output voltage regulation, *Energy Conversion and Management*, 50 (1), 6–13.
- Boukezata, B., Chaoui, A., Gaubert, J.-P. and Hachemi M. (2016). Power Quality Improvement by an Active Power Filter in Grid-connected Photovoltaic Systems with Optimized Direct Power Control Strategy, *Electric Power Components and Systems*, 44 (18), 2036–2047.
- Chung-Yuen, W., Duk-Heon, K., Sei-Chan, K., Won-Sam, K., Hack-Sung, K. (1994). A new maximum power point tracker of photovoltaic arrays using fuzzy controller, *Power Electronics Specialists Conference*, 396–403.
- Guenounou, O., Dahhou, B., and Chabour, F. (2014). Adaptive fuzzy controller based MPPT for photovoltaic systems, *Energy Conversion and Management*, 78, 843–850.
- Merabet, L., Saad, S., Abdeslam, D. O., and Omeiri, A (2013.) A comparative study of harmonic currents extraction by simulation and implementation, *International Journal of Electrical. Power Energy System*, 53(1), 507–514.
- Ouchen, S., Betka, A., Abdeddaim, S., Menadi, A. (2016). Fuzzy-predictive direct power control implementation of a grid connect photovoltaic system, associated with an active power filter. *Energy conversion and Management*, 122, 515-525.
- Rekioua, D., Serir, C. (2013). Control of Photovoltaic Water Pumping System, *International Conference on Electrical Engineering and Automatic Control*.